

Installation instructions for Uridan water-free urinal model GR2400-3-G

Important notes:

- The urinal **must** be installed in accordance with the AS/NZS 3500 Plumbing Requirements
- Ensure that existing sewer pipes are well cleaned and don't have pre-existing blockages
- This Uridan urinal is already trapped. **DO NOT** connect to another p-trap
- Ensure that noggings and studs are positioned at the appropriate height to allow for fastening of mounting bracket
- Please leave customer care booklet, Uriclean cleaning detergent and hook with customer

Installation process

- Position 5 mounting brackets 930mm from floor and at 575mm centres either side of centerline of urinal. See fig1 below for detail.
- Rough-in 50mm PVC DWV waste to 150mm from wall (vertical connection) or 205mm from floor for horizontal waste connection and add 50mm socket or 88 degree bend (F&F) to suit.
- Glue PVC adapter (supplied) into end of socket/bend and grease rubber seal.
- Slide the urinal down over 3 mounting plate ensuring the bottom of the waste trap is secure in the waste outlet.
- Apply silicone sealant around outer edge of urinal and wall if required.

Preparing the urinal for use

- Pour approximately 2 litres of water in the trap, until level with the top of small waste pipe.
- Insert the stainless steel waste cover and then pour 1 bottle of **URILOCK** fluid over the cover
- Allow to drain and then spray bowl with Uriclean and wipe.

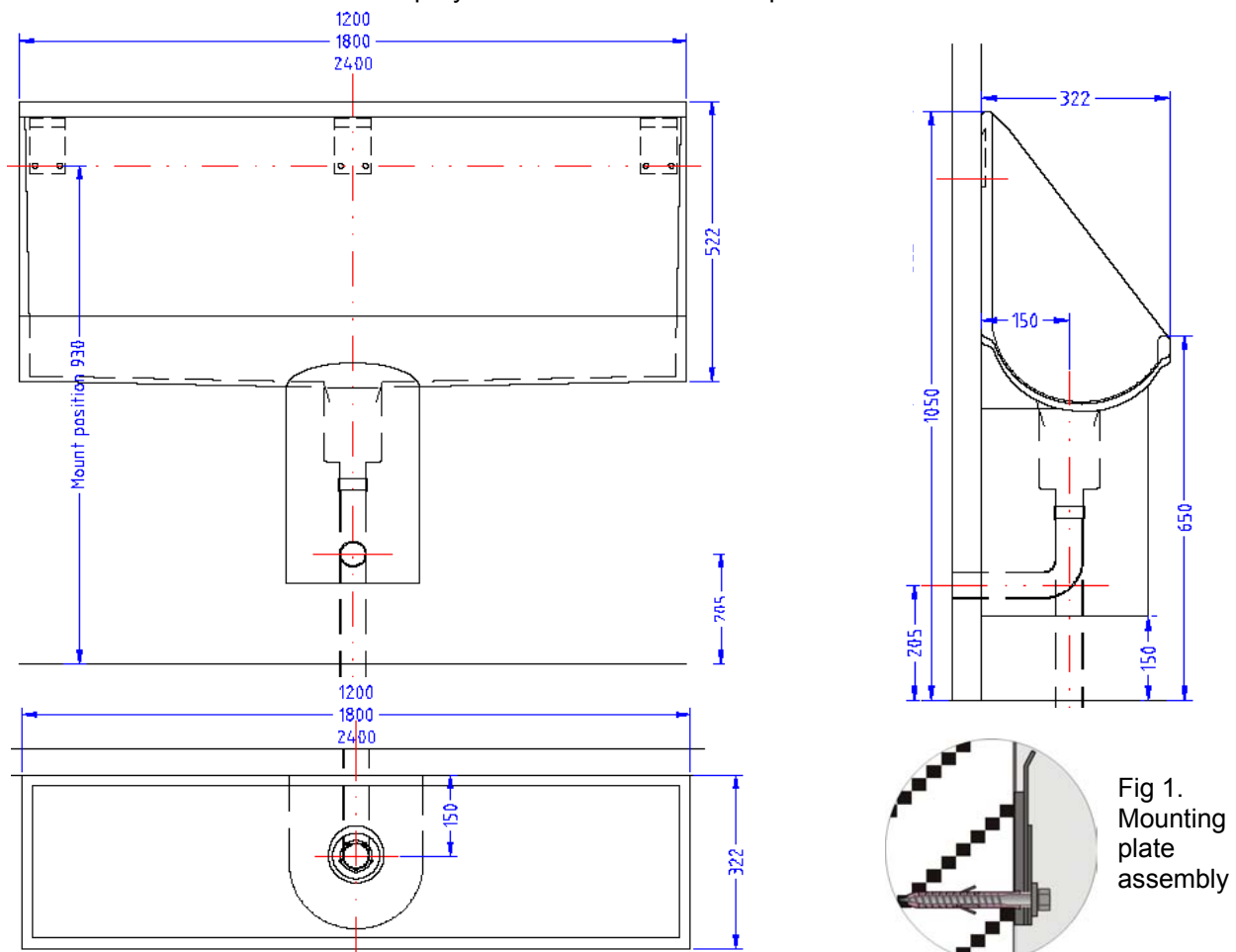

Fig 1.
Mounting
plate
assembly